

WRC



FIA WORLD RALLY
CHAMPIONSHIP

SAS Fitting Kit Manual – RALLY CAR

Welcome

This manual is provided as a guide for the installation of the WRC Tracking System Kit, for competition vehicles only. Care should be taken when considering the location of components with regard to electrical cabling and fire suppression systems already installed in the vehicle. Please always check that the components of your kit are as requested.

Contents

1. Tracking Unit Kit Components & Steps.....	3
2. Tracking Unit Mounting.....	3
3. Remote LED Device (RLD) Mounting.....	6
4. Antenna Installation.....	7
4.1. External Antenna.....	8
4.2. Internal Antenna.....	9
5. Power Supply.....	9
6. Wiring Connection Diagram.....	9
7. Contact Us.....	11

1. Tracking Unit Kit Components & Steps

The WRC Tracking System Kit includes:

- WRC Tracking Installation & Fitting Kit Instruction Sheet;
- 3-in-1 antenna with leads;
- Internal radio antenna with lead;
- 9 – 28v wiring loom with plug;
- Mount base;
- Adjustable mount connector/knuckle.
- RallySafe Tracking Device (Supplied on Event)
- RallySafe Remote LED Device (RLD) (Supplied on Event)



WRC tracking system fitment steps:

1. Mount WRC tracker & RLD keeping in mind the limitations of the cable length between RLD and WRC tracker;
2. Fit external & internal antennas, running leads to the WRC tracker;
3. Fit wiring loom, ensuring that a solid 9 to 28 volts is supplied;
4. Connect all antenna connections, make sure they are tight using an 8mm spanner;
5. Apply power.

2. Tracking Unit Mounting

The preferred location and mounting for the WRC tracking system unit is a RAM style 50mm x 75mm flat base with ball, bolted through the transmission tunnel with four **M6** Bolts.

It should be in a central, protected location on the central tunnel in front of the seats and both easily visible and accessible by both the driver and co-driver.

Care should be taken when considering the location of the Mounting Point with regard to electrical cabling and fire suppression systems installed in the vehicle.

Photographs of mounting and positioning on the tunnel can be seen in Fig.1 and Fig.2, respectively.

Alternatively, the WRC tracking system unit can be mounted in a central protected location on the vehicle dashboard that is easily visible and accessible by both the driver and co-driver.

Mounting is a Ram style 50mm x 75mm flat base with ball, bolted with four **M6** bolts through the dashboard and a compulsory 3mm backing plate measuring no less than 145mm x 120mm.

Photographs of mounting and positioning on the tunnel can be seen in Fig. 3 and Fig. 4, respectively.

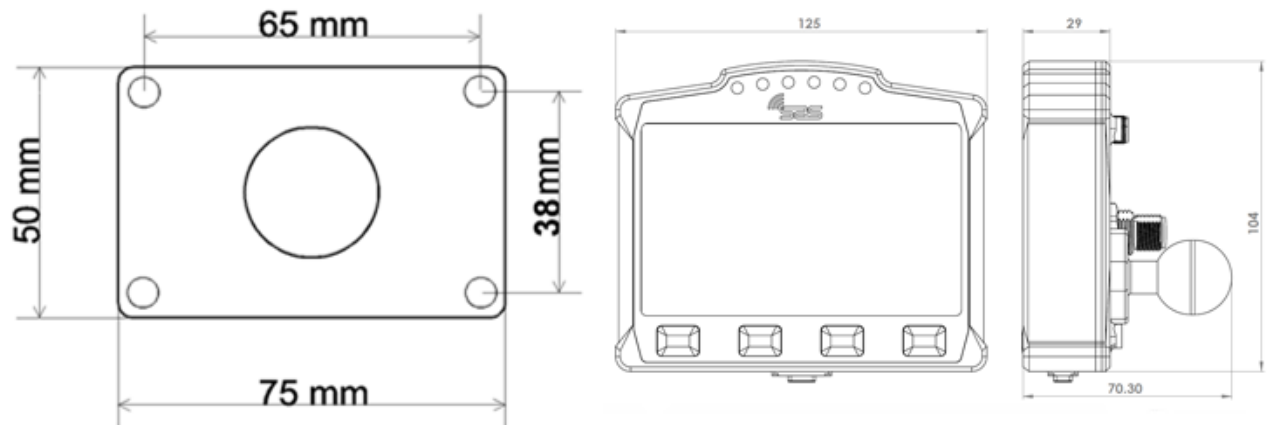

Figure 1. 25mm rubber ball securely attached to the tunnel

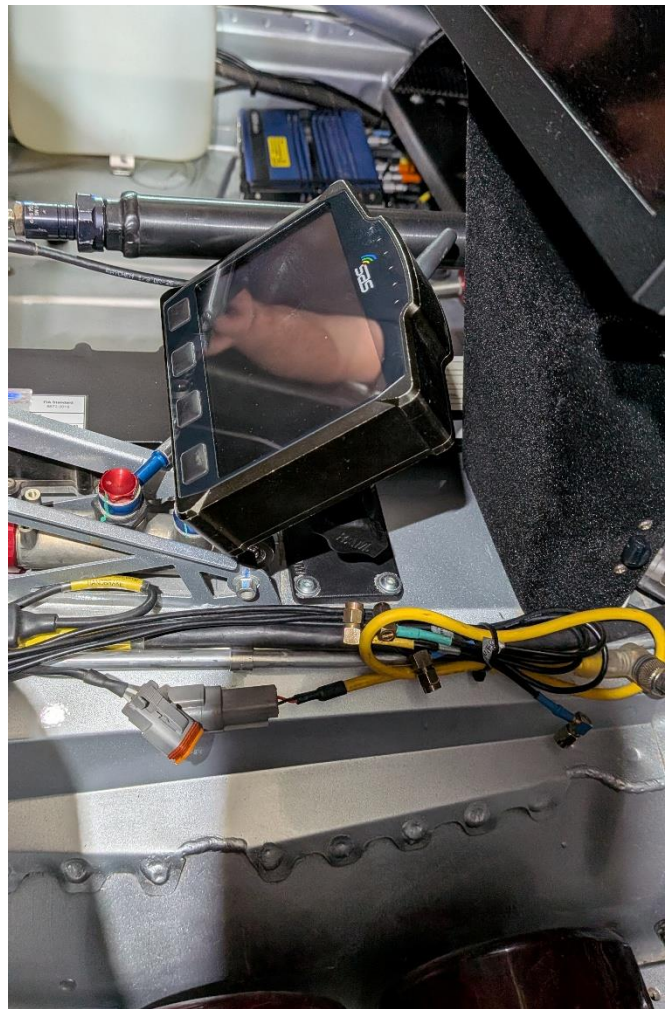

Figure 2. Unit mounted to the tunnel



Figure 3. 25mm rubber ball securely attached to the dashboard



Figure 4. Unit mounted to the dashboard

3. Remote LED Device (RLD) Mounting

The RLD shall be mounted in clear view, directly in front of the driver so that the device and its warnings can be observed easily while competing at speed during a stage. **When mounted near the steering wheel, care must be taken to ensure the steering wheel does not obstruct the driver's view of any LEDs in the normal driving position. Acceptable installation positions are limited to the areas defined by the yellow boundaries in Figure 5.**

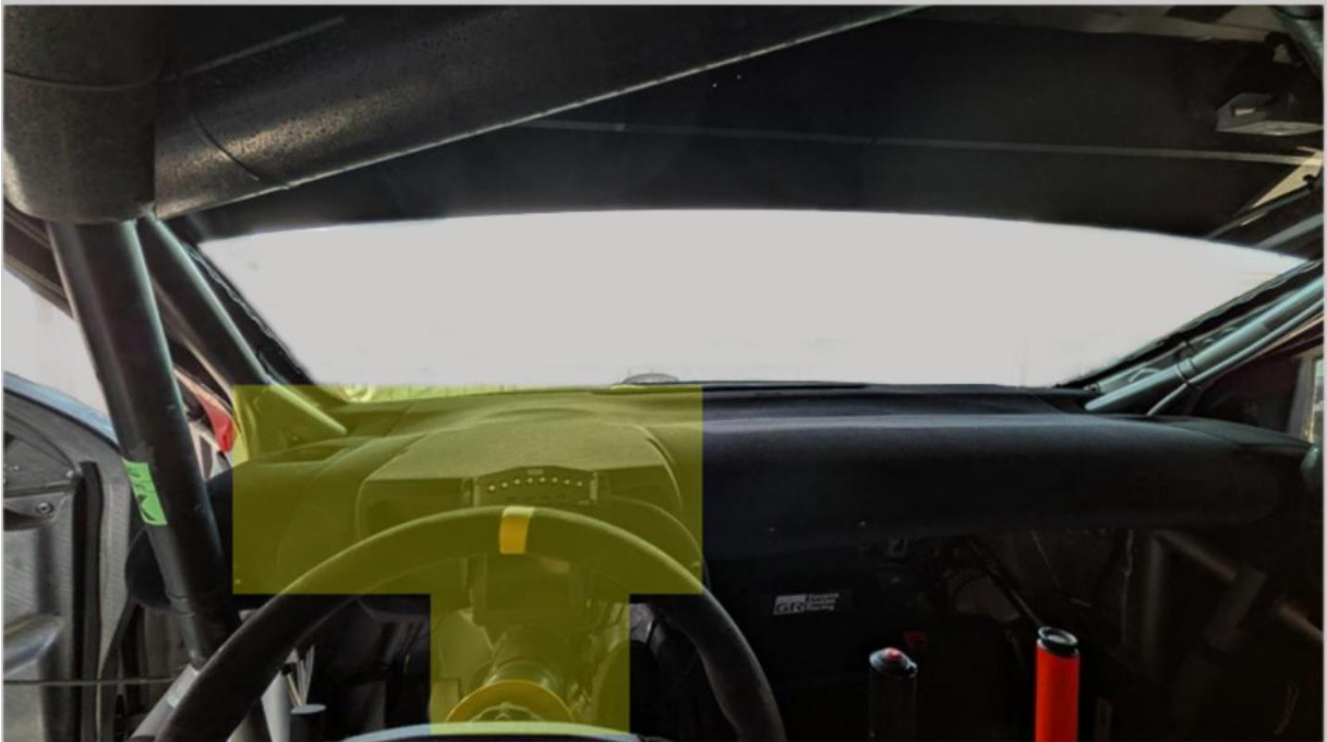

Figure 5. RLD device mounted just **above** the vehicle's steering wheel, **with an alternative yellow view of placement also displayed.**

The RLD shall be mounted using either M5 bolts on the centre holes on the side tabs, or two zip ties using the top and bottom slots, as seen in the diagram below and in Figure 6. The device must be mounted securely so that it cannot move during the event.

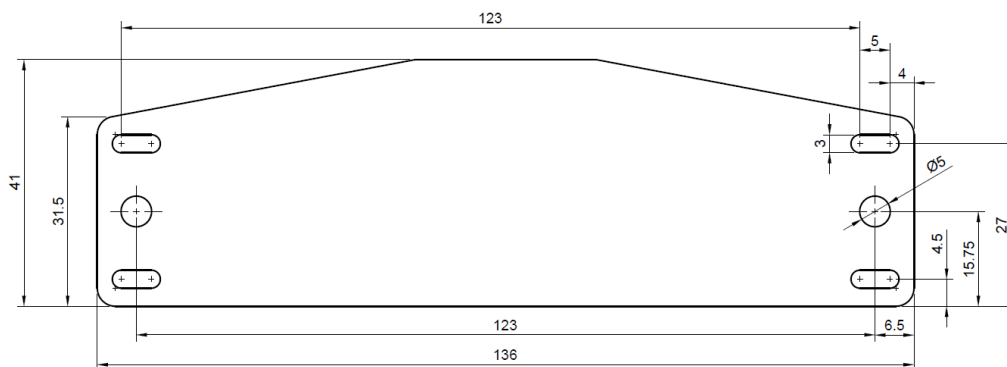



Figure 6. RLD device mounted directly in front of the driver

4. Antenna Installation

All leads on both external and internal antennas must run on the inside of all roll cage bars. This is to stop cable crushing on impact.

Antenna must not be mounted within 200 mm of any high-frequency antenna's or cabling, In addition all cables must not be run alongside on-board camera cables inside the car.

The preferred route is to go down from the antenna, underneath the closest part of the roll cage (roof cross or main hoop), follow that along to the roof hoop, then go down the inside A pillar to the unit.

Any excess cable must be run so that the cable is not bent any tighter than a 100mm radius. We recommend running it along the underside of the dash and back (do not coil it into tight loops).

Cables must be tied neatly along the whole installation, all the way to the unit, so they can't be accidentally caught or dislodged.

All this will be checked at scrutineering, and you may be required to fix it before your car can pass.

Note: All antenna connections need to be firmly tightened with an 8mm spanner.

4.1. External Antenna

The antenna is mounted through a 12mm hole in a central location on the ROOF of the vehicle, rear of the main roll bar hoop, allowing the cabling to pass through the roof and follow the cage bars back to the unit location. The antenna is a fully watertight unit, which seals against the roof surface. The antenna is not to be mounted directly over any roll bar, to avoid it being crushed in a rollover.

Alternatively, the antenna can be mounted at the front right corner of the roof, beside the roof vent.

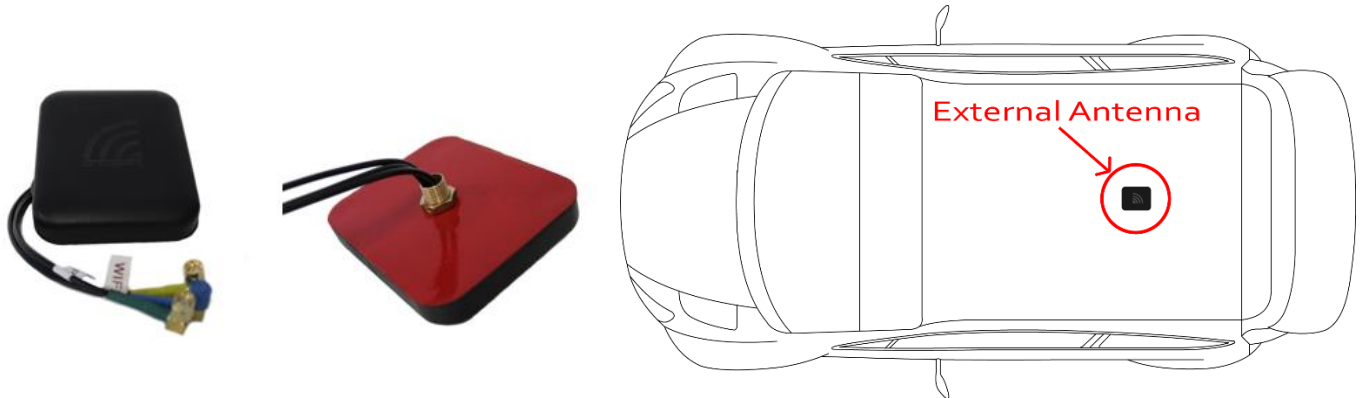

Antenna leads are connected as follows (There may be variations with the type and number of leads).

1. The 2 UHF leads, colour-coded **Blue**, is connected to the terminal labelled "WiFi" on the WRC unit (Right Hand Thread). Terminals are located of the rear of the unit and/or colour-coded Blue.
2. The Satellite Communication antenna lead is connected to the center or rear terminal labelled "IRI" (Left Hand Thread). It may also be colour-coded **Yellow** (this may be not marked on the 2-in-1 antenna).
3. The GPS antenna lead labelled "GPS", is connected to the terminal labelled "GPS" on the WRC unit (Right Hand Thread). Terminals may be on the side or rear of the unit and/or colour-coded **Green**.
4. GSM, has a small stick antenna supplied with the WRC unit, and is connected to corresponding terminal labelled "GSM" on the WRC unit (Left Hand Thread). The terminal is located on the rear of the unit and/or colour-coded **Red**.

4.2. Internal Antenna

The Internal Antenna should be placed on the inside of the ROOF in a clear uncluttered area behind the main rollbar, with a 200mm radius clear of any bar work or solid metal object. The internal antenna has a magnetic base with double-sided tape for adhesion. The cable is then run to the WRC unit. Please keep cable on the inner side of the roll cage pipework so as not to be crushed in the event of an accident.

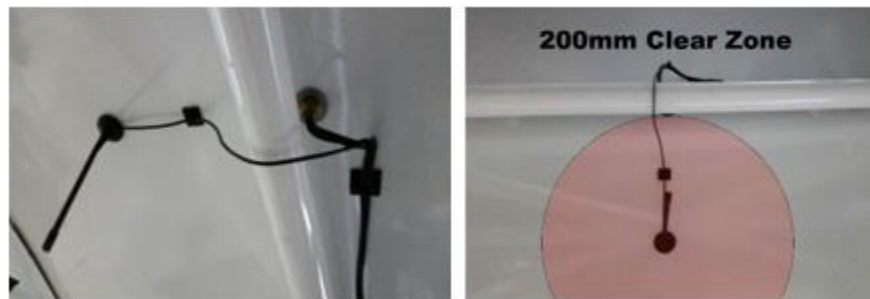

Figure 2. The internal antenna must be at least 200mm away from any roll cage components

5. Power Supply

WRC tracking system requires a reliable power supply from 9 to 28 volts DC. We recommend a 5 amp (Max) blade type or similar quality fuse is used at the battery supply end of the WRC tracking system power lead.

Zero volts or battery negative can be picked up at any suitable earthing point providing the isolation switch does not switch the negative side of the battery.

The WRC tracking system unit has an internal battery that is kept charged via the car's power supply. It acts as a reserve supply to power the unit in the case of an accident where a car's power supply is interrupted (e.g. car battery smashed or dislodged). It's important to note that the RLD does not have an internal battery, and it requires power from the vehicle to function. In the case that the unit displays power loss, the RLD buttons and LEDs will not function.

Note: The tracking device should only be powered once it is placed in its final mounted position and the GREEN LED is displaying on the wiring harness; this ensures accelerometers are calibrated correctly and the polarity is correct. If the polarity is not correct and a RED LED is displayed and the unit is connected, the wiring harness will act as a fuse and be non-functional after this.

6. Wiring Connection Diagram

The 9-28v wiring loom, includes five wires. Only SAS-supplied wiring looms are permitted for connection to the devices (excluding Rally1 cars). The white, blue, and grey wires must be stagger cut and heat-shrunk or taped back so they cannot short to ground or to each other. Red and black are used as follows:

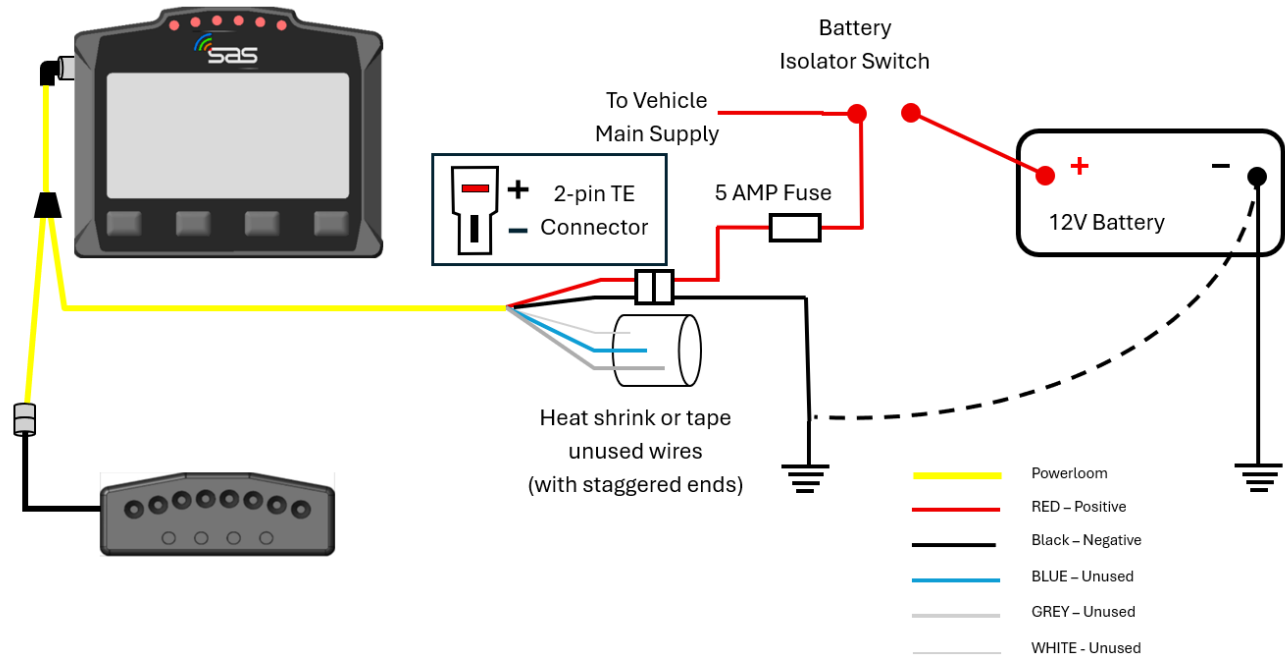

RALLYSAFE 12V WIRING DIAGRAM with REMOTE LED DISPLAY (RLD)

During installation, the wiring loom should be routed away from the engine compartment, Ignition or Alternator wiring.

300 mm of Power Supply Wiring Loom is required to be available for connection to the WRC Tracker Unit at the mounted position, using the clear right-angle connector. The straight black connector shall be routed to the RLD location.

Rented looms will be provided with a TE Connectivity 180908-0 | AMP FASTIN-FASTON SERIES, 2 WAY NYLON 66 CRIMP TERMINAL MALE fitted. This connector must not be removed unless the kit is purchased.

In the case the kit is purchased, the type of power supply connector used may be up to the team, and cable lengths may be shortened if necessary.

A TE Connectivity 180908-0 | AMP FASTIN-FASTON SERIES, 2 WAY NYLON 66 CRIMP TERMINAL TE Connectivity 180907 Connector Receptacle Housing, 2-Position, Straight, Female Socket, Faston Series with Pins will be provided with the kit for installation on the vehicle side. This connector can be permanently left in the car and is not required to be return to SAS.

7. Contact Us

For assistance, please contact the RallySafe Support Team by emailing: wrc@statusas.com

****Product Disclaimer****

“This manual, the specifications, and the material contained in it, as released by Status Awareness Systems and RallySafe, is for the purpose of information only. Due to continuous ongoing development, information and specifications may change at any time without notice. SAS, and the companies that have contributed to it, shall not be liable for any use of the manual or information supplied.

The material contained in this manual is protected by copyright and other types of Intellectual Property Rights. The commercial exploitation of the material contained in this specification requires a license to such Intellectual Property Rights.

This manual may be utilised or reproduced without any modification, in any form or by any means, for informational purposes only. For any other purpose, no part of the specification may be utilised or reproduced, in any form or by any means, without permission in writing from SAS.

The word RallySafe and the RallySafe logo are registered trademarks”.